



**Electrolux**  
PROFESSIONAL

**Modular Cooking Range Line  
thermaline 85 - 800 mm Open  
base, GN conform, 1 Side (H2)**

ITEM # \_\_\_\_\_

MODEL # \_\_\_\_\_

NAME # \_\_\_\_\_

SIS # \_\_\_\_\_

AIA # \_\_\_\_\_



**588579 (MB1BCAHO00)**      Open Base, one-side operated, GN - H2

**Short Form Specification**

**Item No.** \_\_\_\_\_

800 mm wide open base compartment to store pots, pans, sheet pans, etc. with hygienic design and round edges. Internal frame for heavy duty sturdiness in stainless steel. Flat surface construction, easily cleanable. Open storage space in the base accepts GN 1/1 containers. IPX5 water resistant certification.

Configuration: One side operated freestanding base, hygienic class H2.

**Main Features**

- All major components may be easily accessed from the front.
- Unit to be placed below modular top appliances to store pots, pans, sheet pans, etc.

**Construction**

- Storage space in the base of the appliance that can accept GN1/1 containers.
- Hygienic design of the open base compartment with large round edges.
- IPX5 water resistance certification.
- 2 mm top in 1.4301 (AISI 304).
- Flat surface construction with minimal hidden areas to easily clean all surfaces
- Internal frame for heavy duty sturdiness in stainless steel.

**Optional Accessories**

- Stainless steel front kicking strip, 800mm width      PNC 912634
- Stainless steel side kicking strip left and right, wall mounted, 850mm width      PNC 912659
- Stainless steel side kicking strip left and right, back-to-back, 1700mm width      PNC 912662
- Stainless steel side panel, 850x700mm, right side, against wall      PNC 913003
- Stainless steel side panel, 850x700mm, left side, against wall      PNC 913004
- Perforated shelf for warming cabinets and cupboard bases (one-side operated TL80-85-90 and two-side operated for TL80)      PNC 913234
- Side reinforced panel only in combination with side shelf, for against the wall installations, right      PNC 913261
- Side reinforced panel only in combination with side shelf, for against the wall installations, left      PNC 913262
- Shelf fixation for TL80-85-90 one-side operated, TL80 two-side operated      PNC 913281
- Stainless steel dividing panel, 850x700mm, (it should only be used between Electrolux Professional thermaline Modular 85 and thermaline C85)      PNC 913670

**APPROVAL:** \_\_\_\_\_



Experience the Excellence  
[www.electroluxprofessional.com](http://www.electroluxprofessional.com)



**Electrolux**  
PROFESSIONAL

## Modular Cooking Range Line thermaline 85 - 800 mm Open base, GN conform, 1 Side (H2)

- Stainless steel side panel, 850x700mm, PNC 913686   
flush-fitting (it should only be used  
against the wall, against a niche and in  
between Electrolux Professional  
thermaline and ProThermetic  
appliances and external appliances -  
provided that these have at least the  
same dimensions)

Modular Cooking Range Line  
thermaline 85 - 800 mm Open base, GN conform, 1 Side (H2)

The company reserves the right to make modifications to the products  
without prior notice. All information correct at time of printing.

2025.02.13

Front

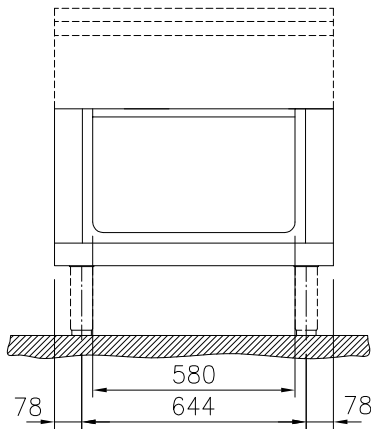

Side

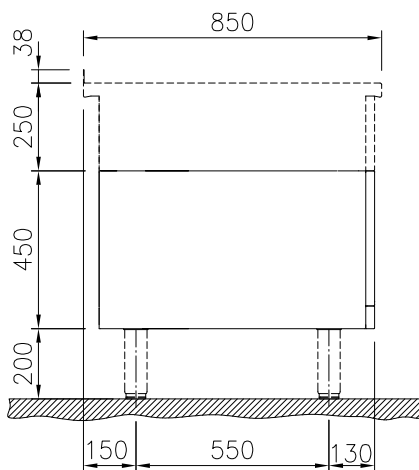

Top

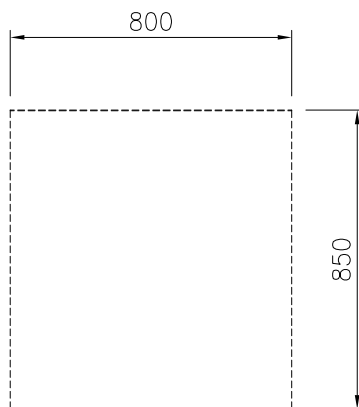
**Key Information:**

External dimensions, Width:	
588579 (MB1BCAH000)	800 mm
External dimensions, Depth:	850 mm
External dimensions, Height:	450 mm
Cupboard Cavity Dimensions (width):	580 mm
Cupboard Cavity Dimensions (height):	330 mm
Cupboard Cavity Dimensions (depth):	740 mm
Net weight:	21 kg